

INSTALLATION OF LOOSE-LAID TILES: SAGA² Technical opinion request pending

FULL BONDING WITH TACKIFIER EMULSION ADHESIVE (RELEASE SYSTEM):
A gripping primer compatible with the tackifier emulsion adhesive and the subfloor must be applied before gluing



In accordance with the local standard



*Tiles must be removed from their box at least 24 hours before they are installed and be placed in the room in which they are to be used.
The material should also be examined before it is installed in order to avoid any visual aspect problems. In the event of any aspect defects, please inform GERFLOR and wait for approval before commencing installation.*

Do not install tiles from different batches in the same room.

Method for treating tile joints according to room E classification:

PRODUCT	TILES	FINISHING METHOD
Resistance to indentation	P3	
E2 classification	Installation in staircase from edge to edge	Edge cutting
INSTALLATION DIRECTION	Installation at 90° NOTE: We advise against installing tiles in the same direction as joints will become more visible.	

SUBFLOOR:

Subfloors must be prepared in compliance with local standard

PARTICULAR CASES:

- If there are temperature differences, maximum difference of 20°, (e.g.: bay window) and / or in high traffic areas, the material must be fully glued down on the area in question with an acrylic adhesive. (Typical installation).
- In the case of a reversible floor, full surface bonding must be applied with an acrylic adhesive.
- In case of a heated floor, wait at least 7 days before introducing any heat.

REMARK:

The visibility of joints will depend on the colour schemes.

■ 1 - FLOORING INSTALLATION

IMPORTANT Installation direction: Installation at 90°

NOTE: We advise against installing tiles in the same direction as joints will be more visible.

- For non directional decors, the line on the cork backing allows the installation direction to be followed.
- For directional decors, the decor allows the installation direction to be followed.

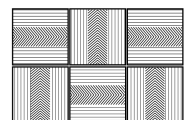

at 90°

1.1 - Setting out

Mark out the starting points according to the requirements shown in the diagram opposite in order to install the tiles.

1.2 - Tile arrangement

Tiles must be arranged to comply with the following requirements:

- Centre one row of tiles along the main centre lines,
- Check that the cut peripheral tiles are larger than half a tile.

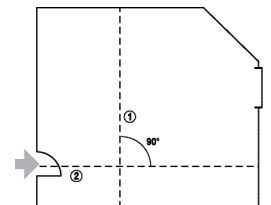

■ 2 - BONDING PRODUCT FOR SAGA2 TILE

For any other adhesives please contact us.

MANUFACTURER	CEGECOL	BOSTIK	EUROCOL	F BALL
PRIMER	Yes Except on metal technical floor	Yes Except on metal technical floor	Yes Except on metal technical floor	Yes Except on metal technical floor
ADHESIVE	CG 100 DPA	ADESI-TECH	541 FIXDAL	F41
COVERAGE	Standard TKB A 4 Spreader 150 / 200 gr/M ²	Standard TKB A 4 Spreader 150 / 200 gr/M ²	Standard TKB A 4 Spreader 150 / 200 gr/M ²	Standard TKB A 4 Spreader 150 / 200 gr/M ²

■ 3 - BONDING

Adhesive is applied by simply spreading one of the products listed above using:

A specification TKB A4 type serrated glue spreader (150 gr/m²). Change spreaders as often as necessary to comply with this requirement.

The adhesive must be applied with a serrated trowel.

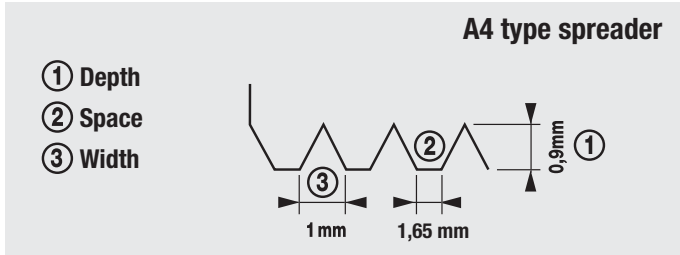

Application recommendations:

- Apply adhesive to the surface without exceeding the work time.
- Comply with the setting time which will depend on the temperature, ambient hygrometry, porosity of the subfloor and the amount of adhesive applied.
- Wait until the adhesive film is translucent before laying the tiles.

■ 4 - INSTALLATION OF TILES

- After full setting of the adhesive, lay the first tile at the intersection of the centre lines.

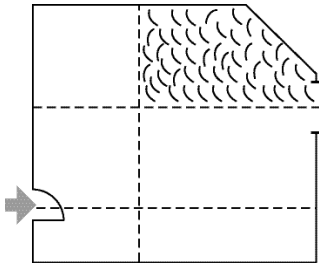

- Lay the next tiles in a staircase configuration. (see diagram opposite).
- Wipe away fresh glue stains with a wet cloth as you work.

INSTALLATION DIRECTION:

See paragraph FLOORING INSTALLATION:

■ 5 - CUTTING

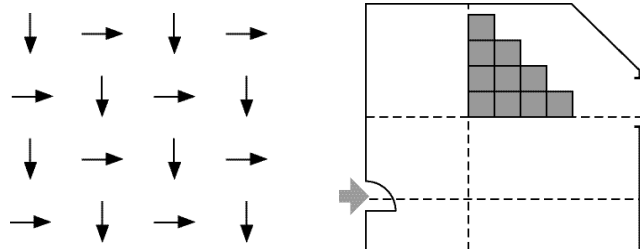

Tiles will be cut by plotting (back technique)

- Position the tile to be cut on the last full tile laid.
- Use a full tile that will be used as a template.
- Lay it on the tile to be cut, in abutment against the wall, do not leave any play.
- Mark the tile to be cut along the edge of the template with a straight edge blade cutter.
- Cleanly cut the part of the tile to be installed, then lay in its place.

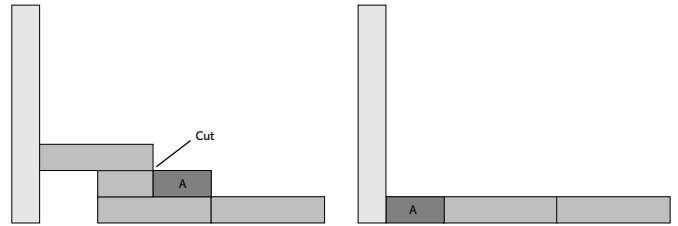

■ 6 - CUTTING OUT AROUND THE BOTTOM OF FRAMES AND DIFFICULT PLACES

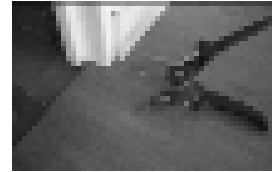

For cutting out around the bottoms of frames and places that are difficult to get at
Available from Gerflor

Mitre cutters - Reference:

Gerflor : 0566 0001 / Janser : 237 530 000



For cutting out around the bottoms of frames and places that are difficult to get at

Downshifted mitre cutters - Reference:

Janser : 262 284 000

■ 7 - SMOOTHING:

Smoothing must be carried out in two stages:

- By hand with a smoothing press as work progresses;
- With a pressure roller on the entire surface at the end of the installation.

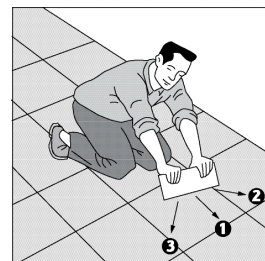

1st stage: Manual smoothing

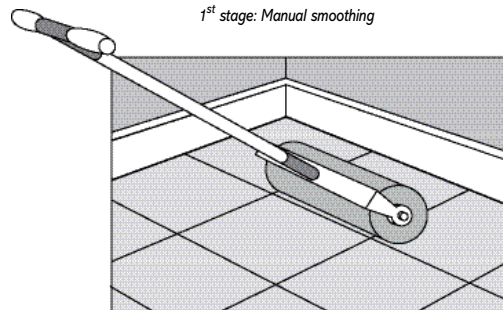

2nd stage: Smoothing with a pressure roller

■ 8 - USE - CIRCULATION

- For normal traffic, 24 hours after installation.
- Arranging or installing furniture, 48 hours after installation.
- Prolonged contact with rubber items may cause permanent discolouration of the tile.